

LED面板灯 筒灯 专家

LED panel lamp downlight expert



中山市睿迪恩斯照明科技有限公司
RADIANCE LIGHTING TECHNOLOGY CO., LTD

工厂地址：广东省中山市古镇镇同益工业区同福南路11号5楼
ADD : 5F , NO11 , Tongfu South Road, Tongyi Industrial Zone , Guzhen Town, Zhongshan City, Guangdong CHINA
TEL : +86 (0760) 88751739
FAX : +86 (0760) 87553213



- 2021 -

中山市睿迪恩斯照明科技有限公司
RADIANCE LIGHTING TECHNOLOGY CO., LTD



公司简介/COMPANY PROFILE

中山市睿迪恩斯照明科技有限公司成立于2011年，位于广东省中山市古镇镇。是一家专业致力于研发，生产、销售LED筒灯,LED面板灯照明产品的公司。

公司长期在照明行业累积的经验和供应链，很好的配合我们公司生产出高品质和高性价比的产品。厂区占地面积3000平方米，拥有自己的办公室，生产车间，已配套现代化的生产线和测试设备。凭借专业的技术，贴心的服务，以及规范的人力资源管理，我们的产品在LED行业一直处于领先的地位。

我们的业务遍及国内、东南亚、中东、非洲，南美洲等。我们有坚定的信心和不断创新的动力，愿与我们的客户以及供应商互利共赢，共创更美好的未来。

Zhongshan RADIANCE Lighting Technology Co., Ltd. was established in 2011 Located in Guzhen Town, Zhongshan City, Guangdong Province Is a professional committed to R & D, production, sales of LED panel lighting LED downlight, products.

The company has accumulated experience and supply chain in lighting industry for a long time, and has cooperated with our company to produce high quality and high cost-effective products. The factory covers an area of 3000 square meters, has its own office, production workshop, has been equipped with modern production lines and testing equipment. With professional technology, considerate service and standardized human resource management, our products have been in a leading position in the LED industry.

Our business covers China, Southeast Asia, the Middle East, Africa, South America and so on. We have firm confidence and continuous innovation drive. We are willing to cooperate with our customers and suppliers to create a better future.



RADIANCE
LIGHTING

铁皮DOB 圆形
Ultra Slim ROUND

DOB 面板灯 筒灯
DOB Panel Light Down Light



高光效
HIGH BIRGHTNESS

安全性强
GREAT SAFETY

型号 MODEL	RC-25-DRD	显色指数 CRI	>80
类型 TYPE	DOB	色容差 SDCM	< 5
电压 INPUT VOLTAGE	AC185-265V	材料 Housing materials	Iron
功率因数 POWER FACTOR	≥0.5	扩散板 DIFFUSER PLATE	PS
工作温度 Working Temperature	-20°C to 50°C	色温 Color temperature	3000K/4000K/6500K

型号 Item No.	尺寸 Lamp Size	开孔尺寸 Hole Size	功率 Power(± 10%)	电压 Input Voltage	频率(Hz) Frequency	光通量 Lumens(± 10%)	显色指数 CRI	功率因数 PF	灯珠 LED quantity
RC-257D-RD	ø118*H30mm	ø90-95mm	7W	AC185-265V	50Hz-60Hz	65lm/w	> 80	≥0.5	22PCS
RC-2512D-RD	ø145*H33mm	ø110-120mm	12W	AC185-265V	50Hz-60Hz	70lm/w	> 80	≥0.5	32PCS
RC-2518D-RD	ø185*H33mm	ø141-150mm	18W	AC185-265V	50Hz-60Hz	75lm/w	> 80	≥0.5	48PCS
RC-2524D-RD	ø225*H33mm	ø175-200mm	24W	AC185-265V	50Hz-60Hz	75lm/w	> 80	≥0.5	64PCS

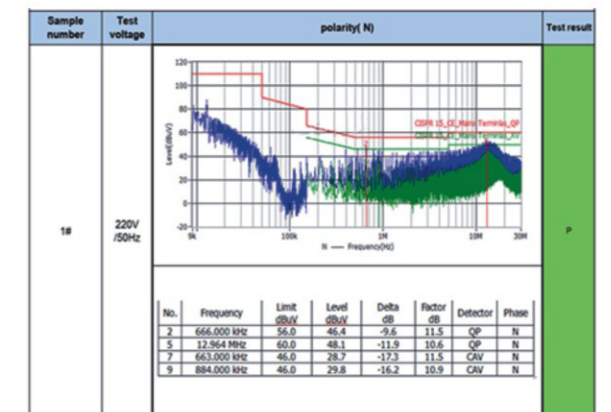



高光效
HIGH BIRGHTNESS



安全性强
GREAT SAFETY

型号 MODEL	RC-25-DSQ	显色指数 CRI	>80
类型 TYPE	DOB	色容差 SDCM	< 5
电压 INPUT VOLTAGE	AC185-265V	材料 Housing materials	Iron
功率因数 POWER FACTOR	≥0.5	扩散板 DIFFUSER PLATE	PS
工作温度 Working Temperature	-20°C to 50°C	色温 Color temperature	3000K/4000K/6500K

型号 Item No.	尺寸 Lamp Size	开孔尺寸 Hole Size	功率 Power(± 10%)	电压 Input Voltage	频率(Hz) Frequency	光通量 Lumens(± 10%)	显色指数 CRI	功率因数 PF	灯珠 LED quantity
RC-2512D-SQ	145*145*H33mm	110-120mm	12W	AC185-265V	50Hz-60Hz	70lm/w	> 80	≥0.5	36PCS
RC-2518D-SQ	185*185*H33mm	141-150mm	18W	AC185-265V	50Hz-60Hz	75lm/w	> 80	≥0.5	48PCS
RC-2524D-SQ	225*225*H33mm	175-200mm	24W	AC185-265V	50Hz-60Hz	75lm/w	> 80	≥0.5	64PCS

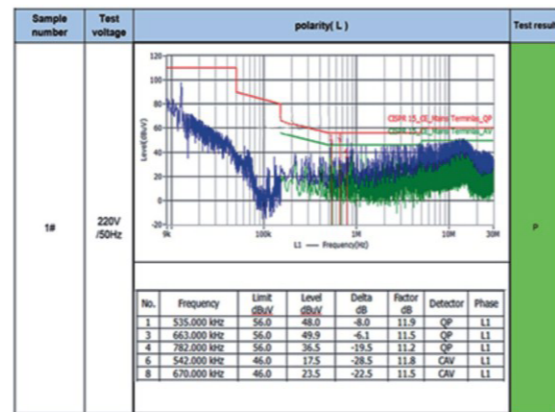
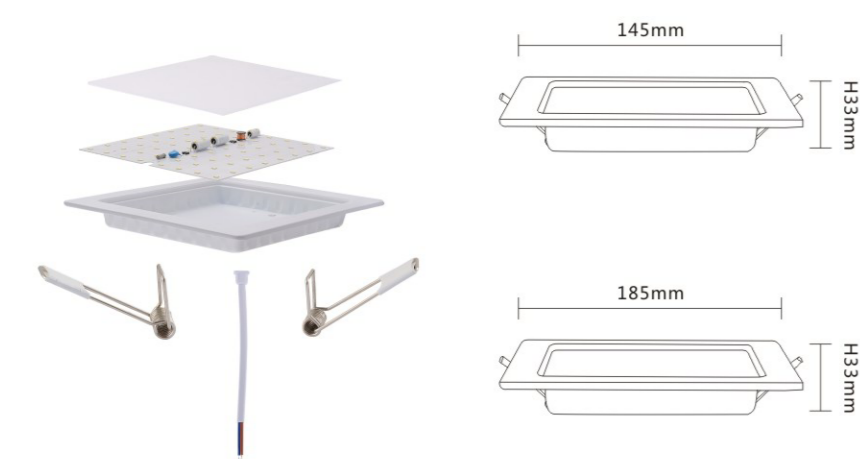

高光效
HIGH BIRGHTNESS



安全性强
GREAT SAFETY

型号 MODEL	RC-25-RD	显色指数 CRI	>80
类型 TYPE	LED	色容差 SDCM	< 5
电压 INPUT VOLTAGE	AC85-265V	材料 Housing materials	Iron
功率因数 POWER FACTOR	≥0.9	扩散板 DIFFUSER PLATE	PS
工作温度 Working Temperature	-20°C to 50°C	色温 Color temperature	3000K/4000K/6500K

型号 Item No.	尺寸 Lamp Size	开孔尺寸 Hole Size	功率 Power(± 10%)	电压 Input Voltage	频率(Hz) Frequency	光通量 Lumens(± 10%)	显色指数 CRI	功率因数 PF	灯珠 LED quantity
RC-2512-RD	ø145*H33mm	ø110-120mm	12W	AC85-265V	50Hz-60Hz	80lm/w	> 80	≥0.9	60PCS
RC-2518-RD	ø185*H33mm	ø141-150mm	18W	AC85-265V	50Hz-60Hz	80lm/w	> 80	≥0.9	90PCS
RC-2524-RD	ø225*H33mm	ø175-200mm	24W	AC85-265V	50Hz-60Hz	80lm/w	> 80	≥0.9	120PCS

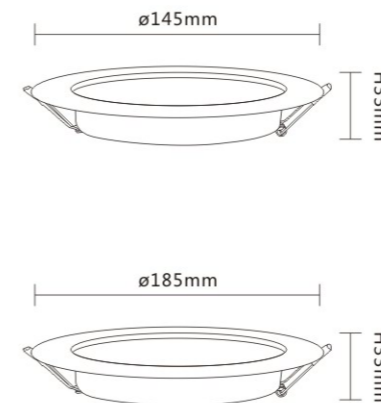

CIE 色度参数

色品坐标: x=0.3171 y=0.3374 u=0.1977 v=0.3156 u*=0.1977 v*=0.4734
 相关色温: 6232 K (duv=+0.0053) 色容差: SDCM(CIE)=3.6 主波长: λd=483.02 nm 色纯度: 0.338
 峰值波长: λp=448.9 nm 质心波长: 540.4 nm 半宽度: Δλp=25.6 nm 色比: R=0.145 G=0.806 B=0.049

显色指数: Ra=81.88
 R1=78.2 R2=84.7 R3=89.9 R4=86.0 R5=83.6 R6=81.0 R7=84.6 R8=66.5
 R9=2.8 R10=64.4 R11=84.6 R12=60.2 R13=79.9 R14=95.1 R15=72.9

色品纯度(COS): Qa=84.9 Qf=76.7 Qp=89.4 Qg=83.6
 Q1=77.4 Q2=83.7 Q3=89.0 Q4=85.1 Q5=82.6 Q6=80.2 Q7=83.8 Q8=65.5
 Q9=1.9 Q10=83.5 Q11=83.6 Q12=59.4 Q13=79.1 Q14=94.1 Q15=72.0

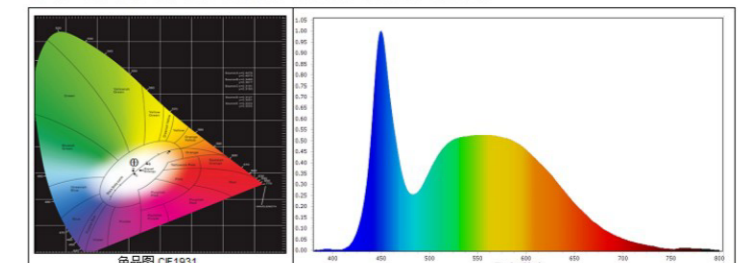



高光效
HIGH BIRGHTNESS

安全性强
GREAT SAFETY

型号 MODEL	RC-25-SQ	显色指数 CRI	>80
类型 TYPE	LED	色容差 SDCM	< 5
电压 INPUT VOLTAGE	AC85-265V	材料 Housing materials	Iron
功率因数 POWER FACTOR	≥0.9	扩散板 DIFFUSER PLATE	PS
工作温度 Working Temperature	-20°C to 50°C	色温 Color temperature	3000K/4000K/6500K

型号 Item No.	尺寸 Lamp Size	开孔尺寸 Hole Size	功率 Power(±10%)	电压 Input Voltage	频率(Hz) Frequency	光通量 Lumens(±10%)	显色指数 CRI	功率因数 PF	灯珠 LED quantity
RC-2512-SQ	145*145*H33mm	110-120mm	12W	AC85-265V	50Hz-60Hz	80lm/w	> 80	≥0.9	60PCS
RC-2518-SQ	185*185*H33mm	141-150mm	18W	AC85-265V	50Hz-60Hz	80lm/w	> 80	≥0.9	90PCS
RC-2524-SQ	225*225*H33mm	175-200mm	24W	AC85-265V	50Hz-60Hz	80lm/w	> 80	≥0.9	120PCS

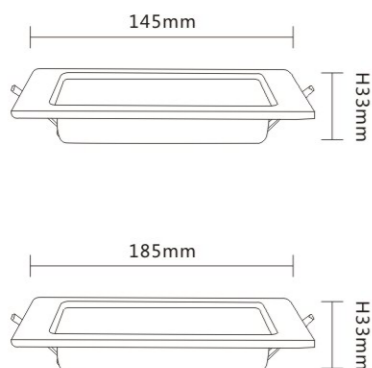

CIE 色度参数

色品坐标 x=0.3171 y=0.3374 u=0.1977 v=0.3156 u'=0.1977 v'=0.4734
 相关色温: 6232 K (duv=+0.0053) 色容差: SDCM(CIE)=3.6 主波长: λd=483.02 nm 色纯度: 0.338
 峰值波长: λp=448.9 nm 质心波长: 540.4 nm 半宽度: Δλp=25.6 nm 色比: R=0.145 G=0.805 B=0.049
 显色指数: Ra=91.88
 R1=78.2 R2=84.7 R3=89.9 R4=86.0 R5=83.6 R6=81.0 R7=84.6 R8=66.5
 R9=2.8 R10=64.4 R11=84.6 R12=60.2 R13=79.9 R14=95.1 R15=72.9
 色品纯度(COS): Qa=84.9 Qf=76.7 Qp=89.4 Qg=83.6
 Q1=77.4 Q2=83.7 Q3=89.0 Q4=85.1 Q5=82.6 Q6=80.2 Q7=83.8 Q8=85.5
 Q9=1.9 Q10=63.5 Q11=83.6 Q12=59.4 Q13=79.1 Q14=94.1 Q15=72.0

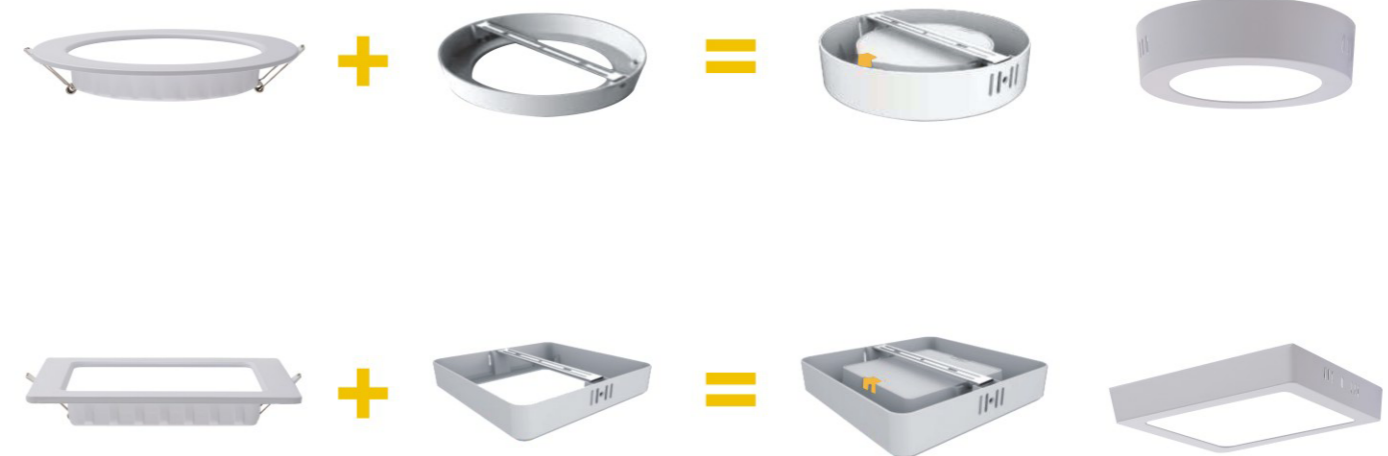
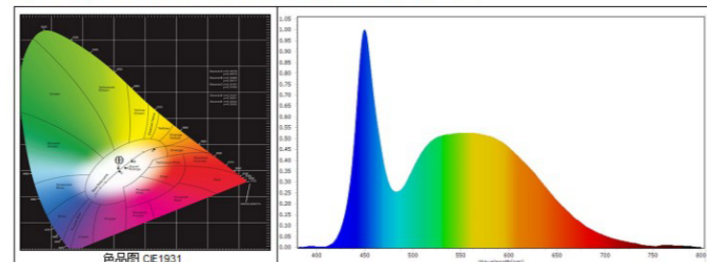

型号 MODEL	RC-25-MY WF	材料 Housing materials	Iron
----------	-------------	----------------------	------

圆形/ROUND

型号 Item No.	尺寸 Lamp Size	功率 Power(±10%)
RC-2518K18MY	ø190*38mm	18W用
RC-2524K24MY	ø230*38mm	24W用

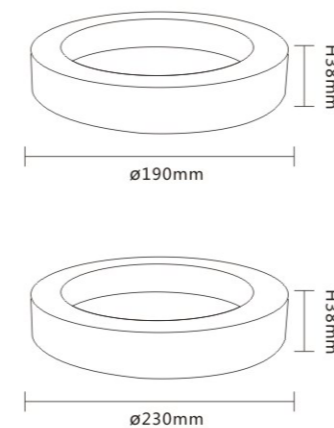

方形/SQUARE

型号 Item No.	尺寸 Lamp Size	功率 Power(±10%)
RC-2518K18WF	ø190*190*38mm	18W用
RC-2524K24WF	ø230*230*38mm	24W用

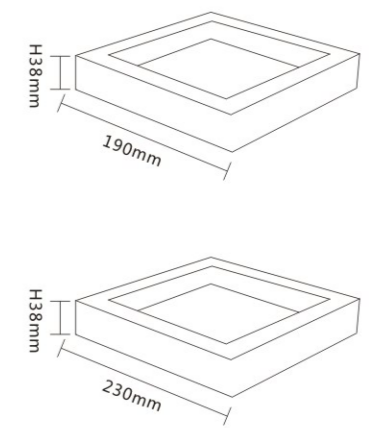



 高光效
HIGH BIRGHTNESS

 安全性强
GREAT SAFETY

型号 MODEL	RC-3712DAY	显色指数 CRI	>80
类型 TYPE	DOB	色容差 SDCM	< 5
电压 INPUT VOLTAGE	AC185-265V	材料 Housing materials	Iron+Glass
功率因数 POWER FACTOR	≥0.5	扩散板 DIFFUSER PLATE	PS
工作温度 Working Temperature	-20°C to 50°C	色温 Color temperature	3000K/4000K/6500K

型号 Item No.	尺寸 Lamp Size	开孔尺寸 Hole Size	功率 Power(±10%)	电压 Input Voltage	频率(Hz) Frequency	光通量 Lumens(±10%)	显色指数 CRI	功率因数 PF	灯珠 LED quantity
RC-3712DAY12W	ø160*H38mm	ø110-120mm	12W	AC185-265V	50Hz-60Hz	65lm/w	> 80	≥0.5	32PCS
RC-3718DAY18W	ø200*H38mm	ø141-150mm	18W	AC185-265V	50Hz-60Hz	70lm/w	> 80	≥0.5	48PCS

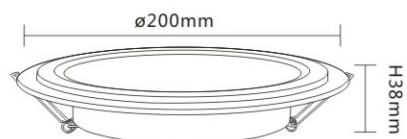
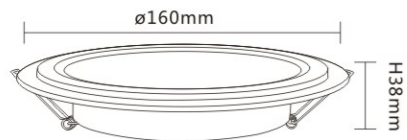

 高光效
HIGH BIRGHTNESS

 安全性强
GREAT SAFETY

型号 MODEL	RC-3712DAF	显色指数 CRI	>80
类型 TYPE	DOB	色容差 SDCM	< 5
电压 INPUT VOLTAGE	AC185-265V	材料 Housing materials	Iron+Glass
功率因数 POWER FACTOR	≥0.5	扩散板 DIFFUSER PLATE	PS
工作温度 Working Temperature	-20°C to 50°C	色温 Color temperature	3000K/4000K/6500K

型号 Item No.	尺寸 Lamp Size	开孔尺寸 Hole Size	功率 Power(±10%)	电压 Input Voltage	频率(Hz) Frequency	光通量 Lumens(±10%)	显色指数 CRI	功率因数 PF	灯珠 LED quantity
RC-3712DAF12W	160*160*H38mm	ø110-120mm	12W	AC185-265V	50Hz-60Hz	65lm/w	> 80	≥0.5	36PCS
RC-3718DAF18W	200*200*H38mm	ø141-150mm	18W	AC185-265V	50Hz-60Hz	70lm/w	> 80	≥0.5	48PCS

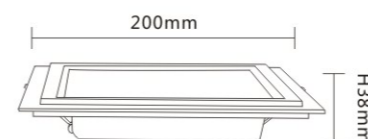
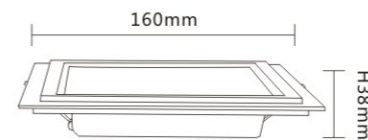



型号 MODEL	RC-2299-RD	显色指数 CRI	>80
类型 TYPE	2835LED	色容差 SDCM	< 5
电压 INPUT VOLTAGE	AC185-265V	材料 Housing materials	Thermal conductive nylon
功率因数 POWER FACTOR	≥0.6	扩散板 DIFFUSER PLATE	PC
工作温度 Working Temperature	-20°C to 45°C	色温 Color temperature	3000K/4000K/6500K

型号 Item No.	尺寸 Lamp Size	开孔尺寸 Hole Size	功率 Power(±10%)	电压 Input Voltage	频率(Hz) Frequency	光通量 Lumens(±10%)	显色指数 CRI	功率因数 PF	灯珠 LED quantity
RC2299-RD12	ø150*H45mm	ø135mm	12W	AC185-265V	50Hz-60Hz	75lm/w	> 80	≥0.6	60PCS
RC2299-RD18	ø175*H45mm	ø160mm	18W	AC185-265V	50Hz-60Hz	75lm/w	> 80	≥0.6	88PCS

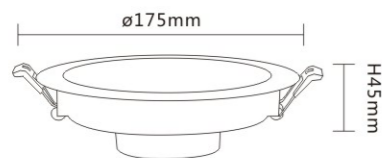
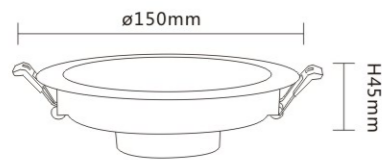

型号 MODEL	RC-2299-SQ	显色指数 CRI	>80
类型 TYPE	2835LED	色容差 SDCM	< 5
电压 INPUT VOLTAGE	AC185-265V	材料 Housing materials	Thermal conductive nylon
功率因数 POWER FACTOR	≥0.6	扩散板 DIFFUSER PLATE	PC
工作温度 Working Temperature	-20°C to 45°C	色温 Color temperature	3000K/4000K/6500K

型号 Item No.	尺寸 Lamp Size	开孔尺寸 Hole Size	功率 Power(±10%)	电压 Input Voltage	频率(Hz) Frequency	光通量 Lumens(±10%)	显色指数 CRI	功率因数 PF	灯珠 LED quantity
RC2299-SQ12	150*150*H45mm	135*135mm	12W	AC185-265V	50Hz-60Hz	75lm/w	> 80	≥0.6	60PCS
Rc2299-SQ18	175*175*H45mm	160*160mm	18W	AC185-265V	50Hz-60Hz	75lm/w	> 80	≥0.6	88PCS

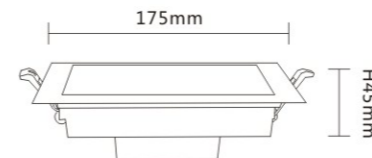
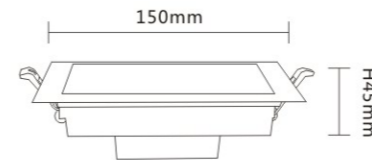



RADIANCE LIGHTING

玻璃 圆形
Glass ROUND

LED 全塑玻璃正发光筒灯
LED Down Light Full plastic Glass



高光效
HIGH BIRGHTNESS



安全性强
GREAT SAFETY



RADIANCE LIGHTING

玻璃 方形
Glass SQUARE

LED 全塑玻璃正发光筒灯
LED Down Light Full plastic Glass



高光效
HIGH BIRGHTNESS



安全性强
GREAT SAFETY

型号 MODEL	RC-2299-RDG	显色指数 CRI	>80
类型 TYPE	2835LED	色容差 SDCM	< 5
电压 INPUT VOLTAGE	AC185-265V	材料 Housing materials	Thermal conductive nylon+Glass
功率因数 POWER FACTOR	≥0.6	扩散板 DIFFUSER PLATE	PC
工作温度 Working Temperature	-20°C to 45°C	色温 Color temperature	3000K/4000K/6500K

型号 Item No.	尺寸 Lamp Size	开孔尺寸 Hole Size	功率 Power(±10%)	电压 Input Voltage	频率(Hz) Frequency	光通量 Lumens(±10%)	显色指数 CRI	功率因数 PF	灯珠 LED quantity
RC2299-RDG12	ø160*H52mm	ø135mm	12W	AC185-265V	50Hz-60Hz	65lm/w	> 80	≥0.6	60PCS
RC2299-RDG18	ø190*H52mm	ø160mm	18W	AC185-265V	50Hz-60Hz	65lm/w	> 80	≥0.6	88PCS

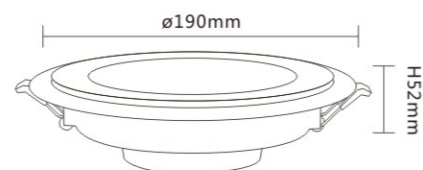

型号 MODEL	RC-2299-SQG	显色指数 CRI	>80
类型 TYPE	2835LED	色容差 SDCM	< 5
电压 INPUT VOLTAGE	AC185-265V	材料 Housing materials	Thermal conductive nylon+Glass
功率因数 POWER FACTOR	≥0.6	扩散板 DIFFUSER PLATE	PC
工作温度 Working Temperature	-20°C to 45°C	色温 Color temperature	3000K/4000K/6500K

型号 Item No.	尺寸 Lamp Size	开孔尺寸 Hole Size	功率 Power(±10%)	电压 Input Voltage	频率(Hz) Frequency	光通量 Lumens(±10%)	显色指数 CRI	功率因数 PF	灯珠 LED quantity
RC2299-SQG12	160*160*H52mm	135*135mm	12W	AC185-265V	50Hz-60Hz	65lm/w	> 80	≥0.6	60PCS
Rc2299-SQG18	190*190*H52mm	160*160mm	18W	AC185-265V	50Hz-60Hz	65lm/w	> 80	≥0.6	88PCS

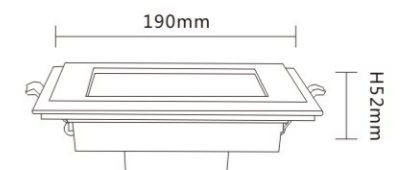
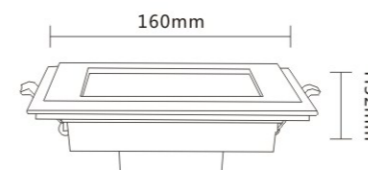



高光效
HIGH BIRGHTNESS

安全性强
GREAT SAFETY

型号 MODEL	RC-2032-RD	显色指数 CRI	>80
类型 TYPE	2835LED	色容差 SDCM	< 5
电压 INPUT VOLTAGE	AC85-265V	材料 Housing materials	Aluminum+Nano light guide plate
功率因数 POWER FACTOR	≥0.9	扩散板 DIFFUSER PLATE	PS
工作温度 Working Temperature	-20°C to 50°C	色温 Color temperature	3000K/4000K/6500K

型号 Item No.	尺寸 Lamp Size	开孔尺寸 Hole Size	功率 Power(±10%)	电压 Input Voltage	频率(Hz) Frequency	光通量 Lumens(±10%)	显色指数 CRI	功率因数 PF	灯珠 LED quantity
RC-2032-RD3	ø85mm	ø70mm	3W	AC85-265V	50Hz-60Hz	65lm/w	> 80	≥0.9	15PCS
RC-2032-RD6	ø120mm	ø100mm	6W	AC85-265V	50Hz-60Hz	65lm/w	> 80	≥0.9	30PCS
RC-2032-RD9	ø140mm	ø120mm	9W	AC85-265V	50Hz-60Hz	70lm/w	> 80	≥0.9	45PCS
RC-2032-RD12	ø170mm	ø155mm	12W	AC85-265V	50Hz-60Hz	75lm/w	> 80	≥0.9	60PCS
RC-2032-RD15	ø200mm	ø170mm	15W	AC85-265V	50Hz-60Hz	75lm/w	> 80	≥0.9	75PCS
RC-2032-RD18	ø220mm	ø200mm	18W	AC85-265V	50Hz-60Hz	80lm/w	> 80	≥0.9	90PCS
RC-2032-RD24	ø300mm	ø280mm	24W	AC85-265V	50Hz-60Hz	80lm/w	> 80	≥0.9	120PCS

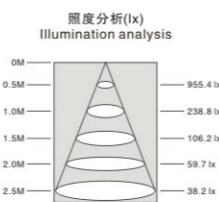
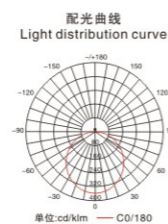
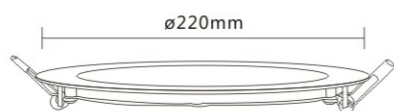
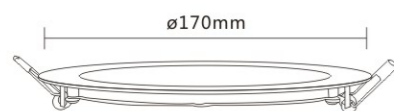

高光效
HIGH BIRGHTNESS

安全性强
GREAT SAFETY

型号 MODEL	RC-2032-SQ	显色指数 CRI	>80
类型 TYPE	2835LED	色容差 SDCM	< 5
电压 INPUT VOLTAGE	AC85-265V	材料 Housing materials	Aluminum+Nano light guide plate
功率因数 POWER FACTOR	≥0.9	扩散板 DIFFUSER PLATE	PS
工作温度 Working Temperature	-20°C to 50°C	色温 Color temperature	3000K/4000K/6500K

型号 Item No.	尺寸 Lamp Size	开孔尺寸 Hole Size	功率 Power(±10%)	电压 Input Voltage	频率(Hz) Frequency	光通量 Lumens(±10%)	显色指数 CRI	功率因数 PF	灯珠 LED quantity
RC-2032-SQ3	85*85mm	70*70mm	3W	AC85-265V	50Hz-60Hz	65lm/w	> 80	≥0.9	15PCS
RC-2032-SQ6	120*120mm	100*100mm	6W	AC85-265V	50Hz-60Hz	65lm/w	> 80	≥0.9	30PCS
RC-2032-SQ9	140*140mm	120*120mm	9W	AC85-265V	50Hz-60Hz	70lm/w	> 80	≥0.9	45PCS
RC-2032-SQ12	170*170mm	155*155mm	12W	AC85-265V	50Hz-60Hz	75lm/w	> 80	≥0.9	60PCS
RC-2032-SQ15	200*200mm	170*170mm	15W	AC85-265V	50Hz-60Hz	75lm/w	> 80	≥0.9	75PCS
RC-2032-SQ18	220*220mm	200*200mm	18W	AC85-265V	50Hz-60Hz	80lm/w	> 80	≥0.9	90PCS
RC-2032-SQ24	300*300mm	280*280mm	24W	AC85-265V	50Hz-60Hz	80lm/w	> 80	≥0.9	120PCS

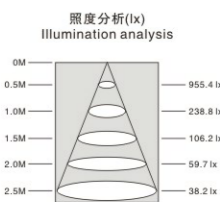
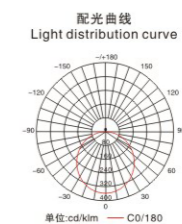
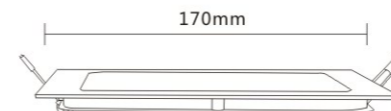



型号 MODEL	RC-2032-RDM	显色指数 CRI	>80
类型 TYPE	2835LED	色容差 SDCM	< 5
电压 INPUT VOLTAGE	AC85-265V	材料 Housing materials	Aluminum+Nano light guide plate
功率因数 POWER FACTOR	≥0.9	扩散板 DIFFUSER PLATE	PS
工作温度 Working Temperature	-20°C to 50°C	色温 Color temperature	3000K/4000K/6500K

型号 Item No.	尺寸 Lamp Size	开孔尺寸 Hole Size	功率 Power(±10%)	电压 Input Voltage	频率(Hz) Frequency	光通量 Lumens(±10%)	显色指数 CRI	功率因数 PF	灯珠 LED quantity
RC-2032-RD6M	ø120*H28mm	ø110mm	6W	AC85-265V	50Hz-60Hz	65lm/w	> 80	≥0.9	30PCS
RC-2032-RD12M	ø170*H28mm	ø160mm	12W	AC85-265V	50Hz-60Hz	75lm/w	> 80	≥0.9	60PCS
RC-2032-RD18M	ø220*H28mm	ø210mm	18W	AC85-265V	50Hz-60Hz	80lm/w	> 80	≥0.9	90PCS
RC-2032-RD24M	ø300*H28mm	ø290mm	24W	AC85-265V	50Hz-60Hz	80lm/w	> 80	≥0.9	120PCS

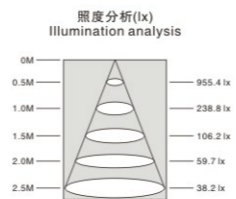
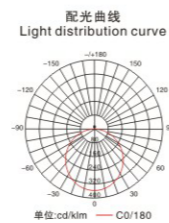
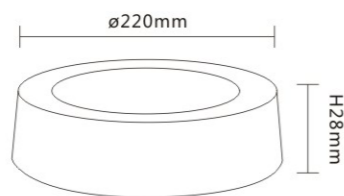
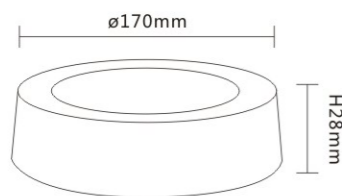

型号 MODEL	RC-2032-SQM	显色指数 CRI	>80
类型 TYPE	2835LED	色容差 SDCM	< 5
电压 INPUT VOLTAGE	AC85-265V	材料 Housing materials	Aluminum+Nano light guide plate
功率因数 POWER FACTOR	≥0.9	扩散板 DIFFUSER PLATE	PS
工作温度 Working Temperature	-20°C to 50°C	色温 Color temperature	3000K/4000K/6500K

型号 Item No.	尺寸 Lamp Size	开孔尺寸 Hole Size	功率 Power(±10%)	电压 Input Voltage	频率(Hz) Frequency	光通量 Lumens(±10%)	显色指数 CRI	功率因数 PF	灯珠 LED quantity
RC-2032-SQ6M	120*120*H28mm	110mm	6W	AC85-265V	50Hz-60Hz	65lm/w	> 80	≥0.9	30PCS
RC-2032-SQ12M	170*170*H28mm	160mm	12W	AC85-265V	50Hz-60Hz	75lm/w	> 80	≥0.9	60PCS
RC-2032-SQ18M	220*220*H28mm	210mm	18W	AC85-265V	50Hz-60Hz	80lm/w	> 80	≥0.9	90PCS
RC-2032-SQ24M	300*300*H28mm	290mm	24W	AC85-265V	50Hz-60Hz	80lm/w	> 80	≥0.9	120PCS

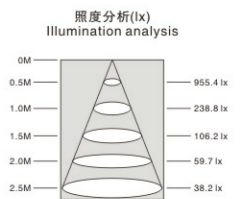
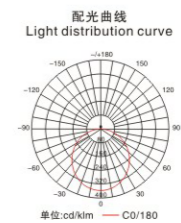
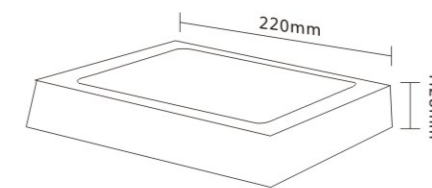
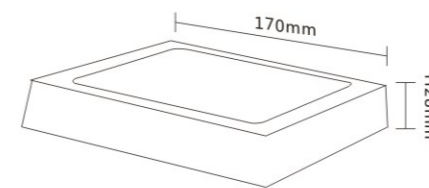



高光效
HIGH BIRGHTNESS

安全性强
GREAT SAFETY

型号 MODEL	RC2185-RD	显色指数 CRI	>80
类型 TYPE	2835LED	色容差 SDCM	< 5
电压 INPUT VOLTAGE	AC85-265V	材料 Housing materials	Aluminum+Nano light guide plate
功率因数 POWER FACTOR	≥0.6	扩散板 DIFFUSER PLATE	PS
工作温度 Working Temperature	-20°C to 45°C	色温 Color temperature	6500K/3000K+Color LED

型号 Item No.	尺寸 Lamp Size	开孔尺寸 Hole Size	功率 Power(±10%)	电压 Input Voltage	频率(Hz) Frequency	光通量 Lumens(±10%)	显色指数 CRI	功率因数 PF	灯珠 LED quantity
RC2185-RD3	∅105mm	∅70mm	3W	AC85-265V	50Hz-60Hz	65lm/w	> 80	≥0.6	15PCS+20
RC2185-RD6	∅145mm	∅105mm	6W	AC85-265V	50Hz-60Hz	65lm/w	> 80	≥0.6	30PCS+30
RC2185-RD12	∅195mm	∅155mm	12W	AC85-265V	50Hz-60Hz	75lm/w	> 80	≥0.6	60PCS+40
RC2185-RD18	∅245mm	∅205mm	18W	AC85-265V	50Hz-60Hz	80lm/w	> 80	≥0.6	90PCS+60

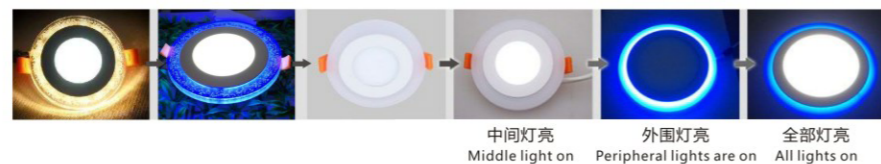
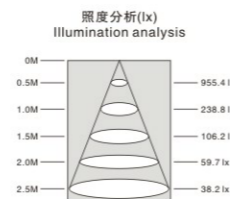
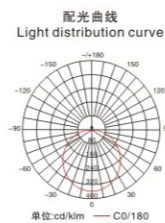
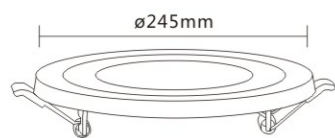
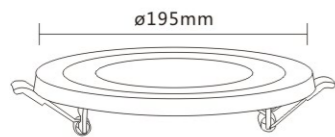

高光效
HIGH BIRGHTNESS

安全性强
GREAT SAFETY

型号 MODEL	RC2185-SQ	显色指数 CRI	>80
类型 TYPE	2835LED	色容差 SDCM	< 5
电压 INPUT VOLTAGE	AC85-265V	材料 Housing materials	Aluminum+Nano light guide plate
功率因数 POWER FACTOR	≥0.6	扩散板 DIFFUSER PLATE	PS
工作温度 Working Temperature	-20°C to 45°C	色温 Color temperature	6500K/3000K+Color LED

型号 Item No.	尺寸 Lamp Size	开孔尺寸 Hole Size	功率 Power(±10%)	电压 Input Voltage	频率(Hz) Frequency	光通量 Lumens(±10%)	显色指数 CRI	功率因数 PF	灯珠 LED quantity
RC2185-SQ3	105*105mm	70*70mm	3W	AC85-265V	50Hz-60Hz	65lm/w	> 80	≥0.6	15PCS+20
RC2185-SQ6	145*145mm	105*105mm	6W	AC85-265V	50Hz-60Hz	65lm/w	> 80	≥0.6	30PCS+30
RC2185-SQ12	195*195mm	155*155mm	12W	AC85-265V	50Hz-60Hz	75lm/w	> 80	≥0.6	60PCS+40
RC2185-SQ18	245*245mm	205*205mm	18W	AC85-265V	50Hz-60Hz	80lm/w	> 80	≥0.6	90PCS+60

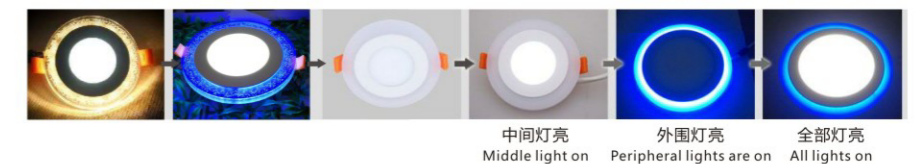
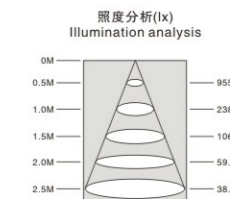
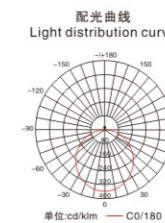
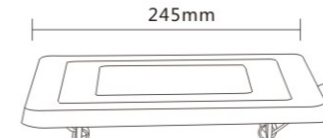
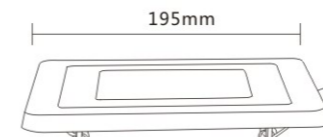



高光效
HIGH BIRGHTNESS



安全性强
GREAT SAFETY

型号 MODEL	RC2185-RDM	显色指数 CRI	>80
类型 TYPE	2835LED	色容差 SDCM	< 5
电压 INPUT VOLTAGE	AC85-265V	材料 Housing materials	Aluminum+Nano light guide plate
功率因数 POWER FACTOR	>0.6	扩散板 DIFFUSER PLATE	PS
工作温度 Working Temperature	-20°C to 45°C	色温 Color temperature	6500K/3000K+Color LED

型号 Item No.	尺寸 Lamp Size	开孔尺寸 Hole Size	功率 Power(±10%)	电压 Input Voltage	频率(Hz) Frequency	光通量 Lumens(±10%)	显色指数 CRI	功率因数 PF	灯珠 LED quantity
RC2185-RDM3	ø105*H32mm	ø70mm	3W	AC85-265V	50Hz-60Hz	65lm/w	>80	≥0.6	15PCS+20
RC2185-RDM6	ø145*H32mm	ø105mm	6W	AC85-265V	50Hz-60Hz	65lm/w	>80	≥0.6	30PCS+30
RC2185-RDM12	ø195*H32mm	ø155mm	12W	AC85-265V	50Hz-60Hz	75lm/w	>80	≥0.6	60PCS+40
RC2185-RDM18	ø245*H32mm	ø205mm	18W	AC85-265V	50Hz-60Hz	80lm/w	>80	≥0.6	90PCS+60

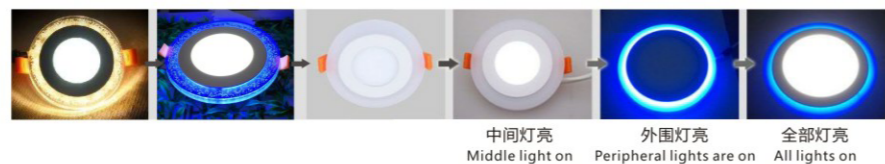
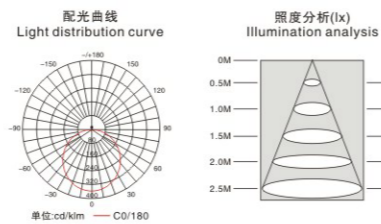
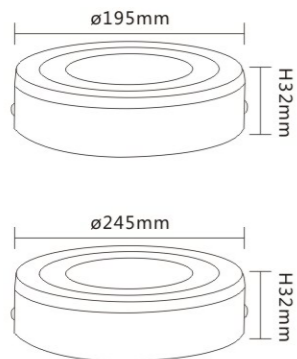

高光效
HIGH BIRGHTNESS



安全性强
GREAT SAFETY

型号 MODEL	RC2185-SQM	显色指数 CRI	>80
类型 TYPE	2835LED	色容差 SDCM	< 5
电压 INPUT VOLTAGE	AC85-265V	材料 Housing materials	Aluminum+Nano light guide plate
功率因数 POWER FACTOR	≥0.6	扩散板 DIFFUSER PLATE	PS
工作温度 Working Temperature	-20°C to 45°C	色温 Color temperature	6500K/3000K+Color LED

型号 Item No.	尺寸 Lamp Size	开孔尺寸 Hole Size	功率 Power(±10%)	电压 Input Voltage	频率(Hz) Frequency	光通量 Lumens(±10%)	显色指数 CRI	功率因数 PF	灯珠 LED quantity
RC2185-SQM3	105*105*H32mm	70*70mm	3W	AC85-265V	50Hz-60Hz	65lm/w	>80	≥0.6	15PCS+20
RC2185-SQM6	145*145*H32mm	105*105mm	6W	AC85-265V	50Hz-60Hz	65lm/w	>80	≥0.6	30PCS+30
RC2185-SQM12	195*195*H32mm	155*155mm	12W	AC85-265V	50Hz-60Hz	75lm/w	>80	≥0.6	60PCS+40
RC2185-SQM18	245*245*H32mm	205*205mm	18W	AC85-265V	50Hz-60Hz	80lm/w	>80	≥0.6	90PCS+60

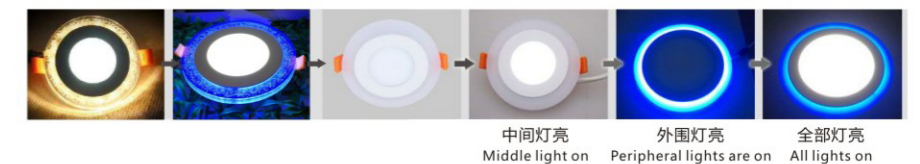
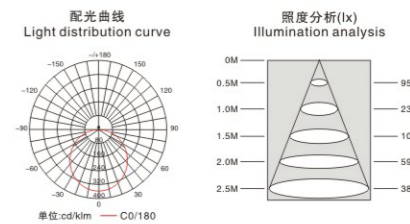
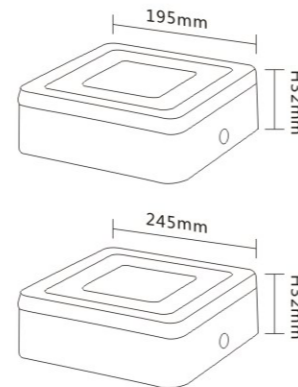



型号 MODEL	RC-32-AY	显色指数 CRI	>80
类型 TYPE	2835LED	色容差 SDCM	< 5
电压 INPUT VOLTAGE	AC85-265V	材料 Housing materials	Aluminum
功率因数 POWER FACTOR	≥0.9	扩散板 DIFFUSER PLATE	PC
工作温度 Working Temperature	-20°C to 50°C	色温 Color temperature	3000K/4000K/6500K

型号 Item No.	尺寸 Lamp Size	开孔尺寸 Hole Size	功率 Power(±10%)	电压 Input Voltage	频率(Hz) Frequency	光通量 Lumens(±10%)	显色指数 CRI	功率因数 PF	灯珠 LED quantity
RC-3210-AY10W	ø90*H33mm	ø65mm	9W	AC85-265V	50Hz-60Hz	70lm/w	>80	≥0.9	45PCS
RC-3218-AY18W	ø120*H33mm	ø100mm	18W	AC85-265V	50Hz-60Hz	80lm/w	>80	≥0.9	90PCS
RC-3220-AY20W	ø145*H33mm	ø120mm	20W	AC85-265V	50Hz-60Hz	80lm/w	>80	≥0.9	108PCS
RC-3224-AY24W	ø170*H33mm	ø150mm	24W	AC85-265V	50Hz-60Hz	85lm/w	>80	≥0.9	144PCS
RC-3236-AY32W	ø225*H33mm	ø200mm	36W	AC85-265V	50Hz-60Hz	85lm/w	>80	≥0.9	252PCS

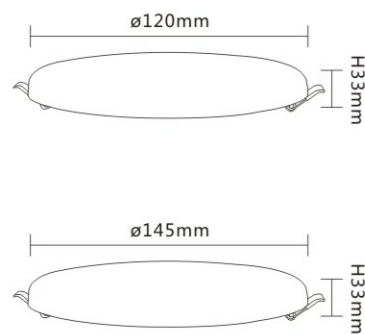

型号 MODEL	RC-32-AF	显色指数 CRI	>80
类型 TYPE	2835LED	色容差 SDCM	< 5
电压 INPUT VOLTAGE	AC85-265V	材料 Housing materials	Aluminum
功率因数 POWER FACTOR	≥0.9	扩散板 DIFFUSER PLATE	PC
工作温度 Working Temperature	-20°C to 50°C	色温 Color temperature	3000K/4000K/6500K

型号 Item No.	尺寸 Lamp Size	开孔尺寸 Hole Size	功率 Power(±10%)	电压 Input Voltage	频率(Hz) Frequency	光通量 Lumens(±10%)	显色指数 CRI	功率因数 PF	灯珠 LED quantity
RC-3210-AF10W	90*90*H33mm	65*65mm	9W	AC85-265V	50Hz-60Hz	70lm/w	>80	≥0.9	50PCS
RC-3218-AF18W	120*120*H33mm	100*100mm	18W	AC85-265V	50Hz-60Hz	80lm/w	>80	≥0.9	90PCS
RC-3220-AF20W	145*145*H33mm	120*120mm	20W	AC85-265V	50Hz-60Hz	80lm/w	>80	≥0.9	108PCS
RC-3224-AF24W	170*170*H33mm	150*150mm	24W	AC85-265V	50Hz-60Hz	85lm/w	>80	≥0.9	168PCS
RC-3236-AF32W	225*225*H33mm	200*200mm	36W	AC85-265V	50Hz-60Hz	85lm/w	>80	≥0.9	288PCS

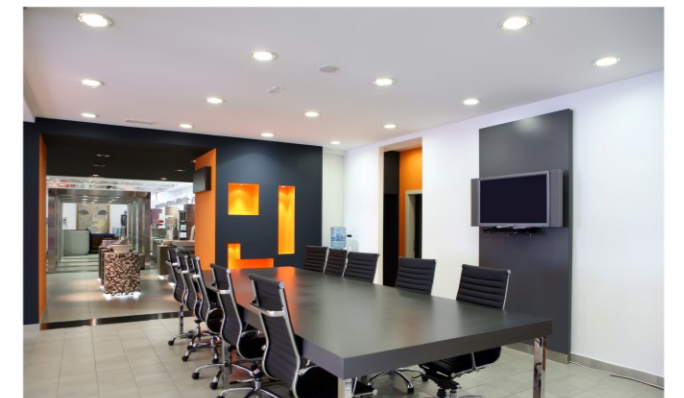
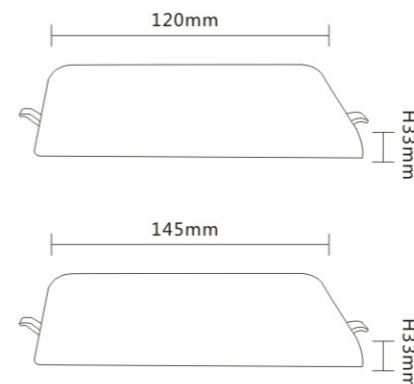



型号 MODEL	RC-2618-MY	显色指数 CRI	>80
类型 TYPE	2835LED	色容差 SDCM	< 5
电压 INPUT VOLTAGE	AC85-265V	材料 Housing materials	Aluminum
功率因数 POWER FACTOR	≥0.9	扩散板 DIFFUSER PLATE	PC
工作温度 Working Temperature	-20°C to 50°C	色温 Color temperature	3000K/4000K/6500K

型号 Item No.	尺寸 Lamp Size	开孔尺寸 Hole Size	功率 Power(±10%)	电压 Input Voltage	频率(Hz) Frequency	光通量 Lumens(±10%)	显色指数 CRI	功率因数 PF	灯珠 LED quantity
RC-2618-MY18W	ø123*H43mm	ø110mm	18W	AC85-265V	50Hz-60Hz	80lm/w	>80	≥0.9	90PCS
RC-2618-MY24W	ø175*H43mm	ø160mm	24W	AC85-265V	50Hz-60Hz	85lm/w	>80	≥0.9	144PCS
RC-2618-MY36W	ø225*H43mm	ø200mm	36W	AC85-265V	50Hz-60Hz	85lm/w	>80	≥0.9	252PCS

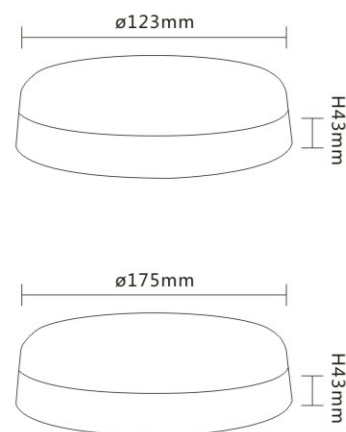

型号 MODEL	RC-2618-MF	显色指数 CRI	>80
类型 TYPE	2835LED	色容差 SDCM	< 5
电压 INPUT VOLTAGE	AC85-265V	材料 Housing materials	Aluminum
功率因数 POWER FACTOR	≥0.9	扩散板 DIFFUSER PLATE	PC
工作温度 Working Temperature	-20°C to 50°C	色温 Color temperature	3000K/4000K/6500K

型号 Item No.	尺寸 Lamp Size	开孔尺寸 Hole Size	功率 Power(±10%)	电压 Input Voltage	频率(Hz) Frequency	光通量 Lumens(±10%)	显色指数 CRI	功率因数 PF	灯珠 LED quantity
RC-2618-MF18W	123*123*H43mm	110*110mm	18W	AC85-265V	50Hz-60Hz	80lm/w	>80	≥0.9	90PCS
RC-2618-MF24W	175*175*H43mm	160*160mm	24W	AC85-265V	50Hz-60Hz	85lm/w	>80	≥0.9	168PCS
RC-2618-MF36W	225*225*H43mm	200*200mm	36W	AC85-265V	50Hz-60Hz	85lm/w	>80	≥0.9	288PCS

